

 GC-heat®

The highest degree.



GC-cart Hochleistungsheizpatronen
GC-cart High-density cartridge heaters



GC-cart

GC-cart

Hochleistungsheizpatronen High-density cartridge heaters

GC-cart Hochleistungsheizpatronen garantieren durch ein spezielles Herstellungsverfahren und durch den Einsatz hochwertiger Materialien eine hohe Standfestigkeit auch unter schwierigen Betriebsbedingungen. Hohe Oberflächenbelastungen ermöglichen eine entsprechend große Leistung auf kleinem Einbauraum, bei Betriebstemperaturen von bis zu 750 °C am Heizpatronenmantel. GC-cart Hochleistungsheizpatronen entsprechen in metrischen und Zollmaßen internationalen Normen. Wir gehen auf individuelle Kundenwünsche ein und fertigen auf Anfrage Durchmesser zwischen 6 mm und 45 mm. Für besondere Einsatzfälle bietet GC-heat die Entwicklung und Fertigung von kundenspezifischen Ausführungen, zum Beispiel mit individueller Leistungsverteilung, schaltbaren Heizzonen, integriertem Thermoelement sowie Ein- und Ausbauhilfen. Unterschiedliche Zuleitungsarten ermöglichen darüber hinaus die Anpassung der GC-heat Hochleistungsheizpatronen an die jeweilige Einbausituation.

Due to a special manufacturing process and the use of high-quality materials, GC-cart high-density cartridge heaters guarantee a high level of stability even under difficult operating conditions. High surface loads enable equally high performance in a compact space, even at operating temperatures of up to 750 °C on the cartridge heater's sheath. GC-cart high-density cartridge heaters conform to metric and imperial international norms. We cater to individual customer requirements and produce diameters between 6 mm and 45 mm on request. GC-heat is also able to design and produce bespoke versions for special applications, e.g. with individual power distribution, switchable heating zones and integrated thermocouples, as well as mounting and dismantling aids. Various leads enable the GC-heat high-density cartridge heaters to be adapted to suit the particular application.

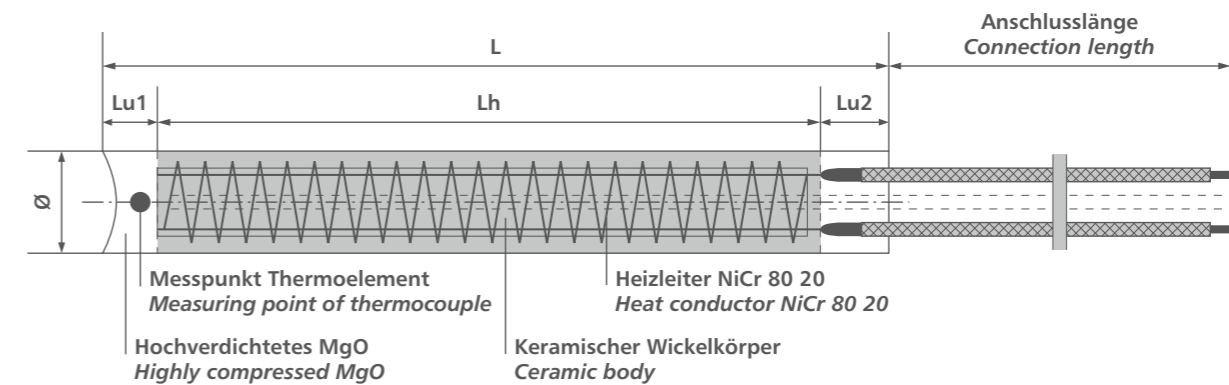

Technische Möglichkeiten und Varianten Technical possibilities and options

- Hohe Leistung auf kleinem Einbauraum
High performance in compact spaces
- Individuelle Leistungsverteilung
Individual power distribution
- Schaltbare Zonen
Switchable zones
- Integriertes Thermoelement
Integrated thermocouple
- Unterschiedliche Zuleitungsarten und Anschlusstypen
Various leads and connections
- Stückprüfung nach VDE0721
Individual quality inspection according to VDE0721
- Auch als explosionsgeschützte Ausführung erhältlich
(siehe Seite 48)
Also available as explosion proof version (see page 48)

Einsatzbereiche Applications

- Kunststoffindustrie
Plastic industry
- Heißkanaltechnik
Hot runner systems
- Verpackungsanlagen
Packaging machines
- Medizinische Geräte
Medical equipment
- Gießereitechnik
Foundry technology
- Zahlreiche weitere thermische Bearbeitungsprozesse
Numerous other thermal processes

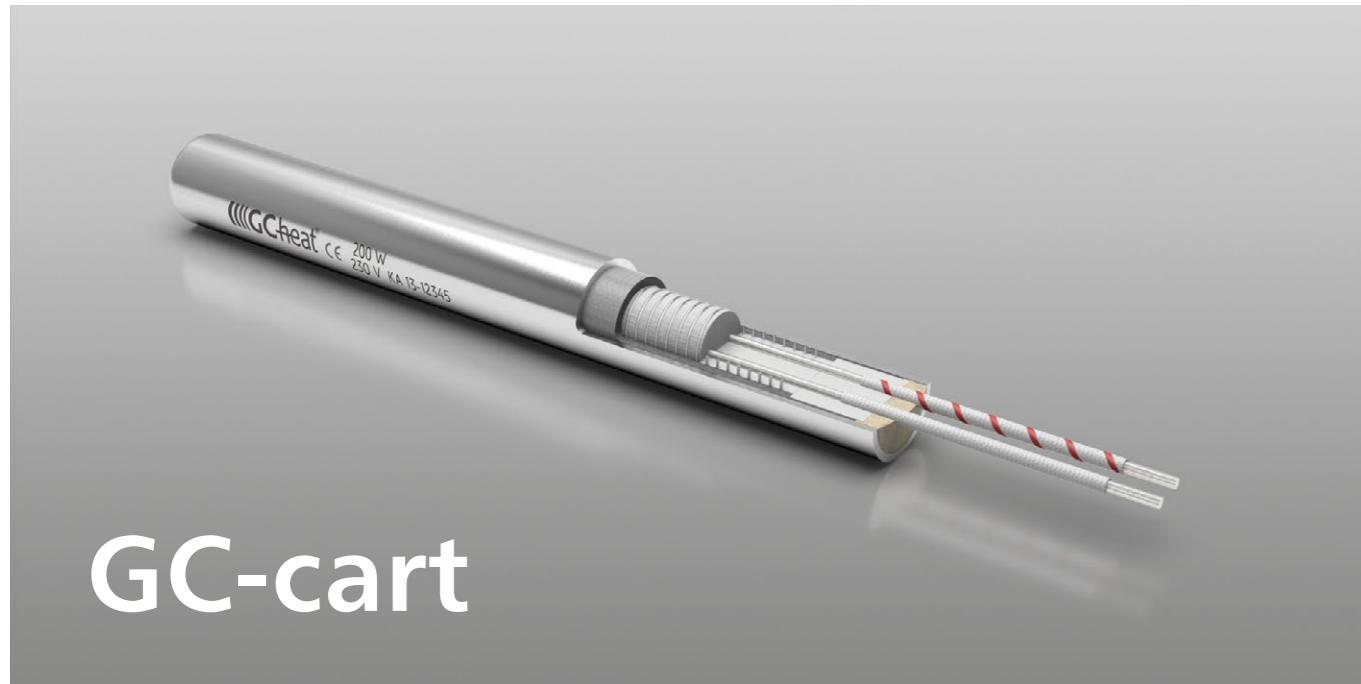

GC-cart

Standardausführung Standard version

Anschlussverguss Connection encapsulation

- Keramikkitt, Silikonverguss, Epoxidharz, PTFE-Scheibe
Ceramic filler, silicone encapsulation, epoxy resin, PTFE disc

Allgemeine Merkmale General characteristics

- Anschluss: standardmäßig glasseidenisolierte Litze, 1000 mm
Weitere Varianten: siehe Seite 38
Connection: 1000 mm standard glass-fibre-insulated lead
For other versions, see page 38

- Isolationswiderstand: > 5 MΩ
Insulation resistance: >5 MΩ
- Mantel-/Betriebstemperatur: max. 750 °C
Sheath/operating temperature: max. 750 °C
- Qualitätskontrolle: nach VDE0721
Quality assurance: according to VDE0721
- Sonderlösungen: Auf Anfrage fertigen wir auch abweichende Abmessungen
Special solutions: different sizes can be made on request

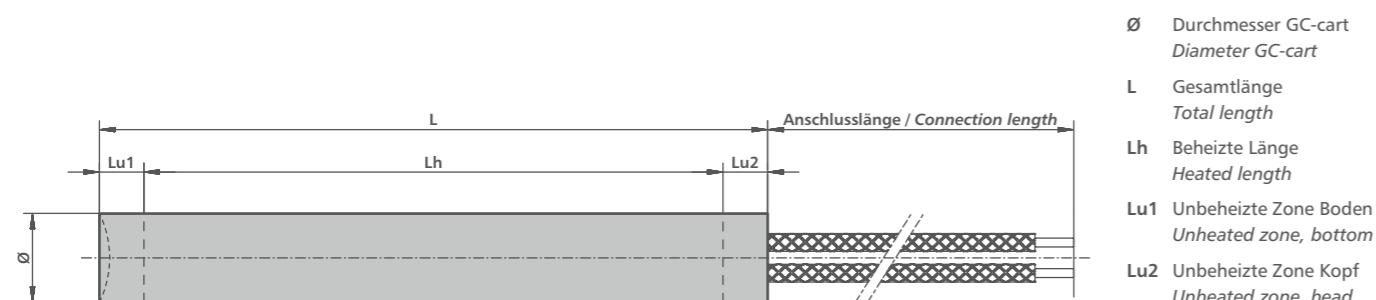

Ø Durchmesser GC-cart
Diameter GC-cart

L Gesamtlänge
Total length

Lh Beheizte Länge
Heated length

Lu1 Unbeheizte Zone Boden
Unheated zone, bottom

Lu2 Unbeheizte Zone Kopf
Unheated zone, head

ООО «ТИ-Системс» ИНЖИНИРИНГ И ПОСТАВКА ТЕХНОЛОГИЧЕСКОГО ОБОРУДОВАНИЯ

Интернет: www.tisys.ru www.tisys.kz www.tisys.by www.ti-systems.com Auf Anfrage. Other designs available on request.

Телефоны для связи: +7 (495) 7774788, (925) 7489626, 5007154, 55, 65

Эл. почта: info@tisys.ru info@tisys.kz info@tisys.by

GC-cart Hochleistungsheizpatrone GC-cart high-density cartridge heater	6.0 – 6.2	6.3 – 7.5	7.8 – 9.0	9.3 – 11.5	11.9 – 12.5
Anschlussspannung Connection voltage	max. 415 V		max. 500 V		
Max. Oberflächenbelastung Max. surface load	50 W/cm ²				
Durchmessertoleranz Diameter tolerance	-0.02 mm / -0.06 mm				
Längentoleranz Length tolerance	± 1.5%, min. ± 1 mm				
Leistungstoleranz Wattage tolerance	± 10%				
Unbeheizt am Boden* (Lu1) Unheated at the bottom (Lu1)	min. 6 mm				
Unbeheizt am Kopf* (Lu2) Unheated at the head (Lu2)	min. 6 mm		min. 7 mm		
Thermoelement Typ K / Typ J Thermocouple type K / type J	□ Lage frei wählbar Freely selectable position				
Widerstandsthermoelement PT 100 Resistance thermocouple PT 100	-		□		
Hochspannungsfestigkeit High-voltage stability	1000 V		1250 V		1500 V
Mantelmaterial Sheath material	CrNi-Stahl CrNi steel				
Leistungsverteilung Wattage distribution	□				
Zonen einzeln schaltbar Zones individually switchable	-		□ max. mit 4 Litzen with max. 4 leads		

GC-cart Hochleistungsheizpatrone GC-cart high-density cartridge heater	12.6 – 17.0	17.8 – 20.4	22.0	24.7 – 26.0	29.0 – 32.5
Anschlussspannung Connection voltage	max. 500 V				
Max. Oberflächenbelastung Max. surface load	50 W/cm ²				
Durchmessertoleranz Diameter tolerance	-0.02 mm / -0.06 mm				
Längentoleranz Length tolerance	± 1.5%, min. ± 1 mm				
Leistungstoleranz Wattage tolerance	± 10%				
Unbeheizt am Boden* (Lu1) Unheated at the bottom (Lu1)	min. 11 mm		min. 12 mm		min. 23 mm
Unbeheizt am Kopf* (Lu2) Unheated at the head (Lu2)	min. 10 mm			min. 12 mm	
Thermoelement Typ K / Typ J Thermocouple type K / type J	□ Lage frei wählbar Freely selectable position				
Widerstandsthermoelement PT 100 Resistance thermocouple PT 100	□				
Hochspannungsfestigkeit High-voltage stability	1500 V				
Mantelmaterial Sheath material	CrNi-Stahl CrNi steel				
Leistungsverteilung Wattage distribution	□				
Zonen einzeln schaltbar Zones individually switchable	□ max. mit 4 Litzen with max. 4 leads			□ max. mit 6 Litzen with max. 6 leads	

Technische Änderungen und Irrtümer vorbehalten. Technical changes and errors excepted.

■ Standardausführung Standard version

□ Optionale Ausführung Optional version

— Nicht verfügbar Not available

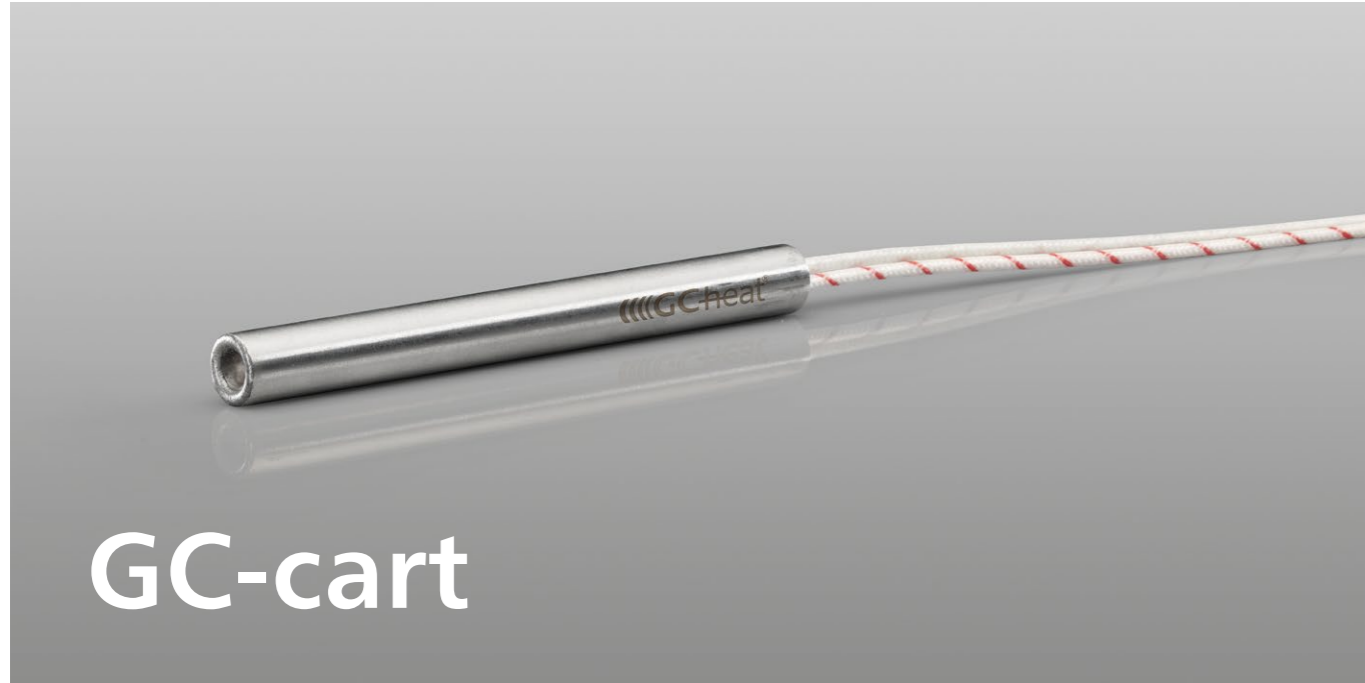

GC-cart

GC-cart

Anschlusstypen Connection types

Litzen, einreduziert Continuous leads

G Glasseidenisierte Litze, silikongetränkt,
max. 350 °C
Glass silk insulated leads, max. 350 °C

SFG Glasseidenisierte Litze, verstärkte Ausführung,
max. 450 °C
Glass silk insulated leads, strengthened version
max. 450 °C

T PTFE-isolierte Litze, max. 260 °C
PTFE leads, max. 260 °C

SLV Silikonlitze, max. 180 °C
Silicone leads, max. 180 °C

SLF Flexible Silikonlitze, max. 180 °C
Highly flexible silicone leads, max. 180 °C

M Glasseidenisierte Litze, hochtemperatur-
beständig, max. 600 °C
High-temperature glass silk insulated leads,
max. 600 °C

Beperte, blanke Litze Beaded leads

P Beperte Nickellitze, max. 750 °C
Ceramic beads, max. 750 °C

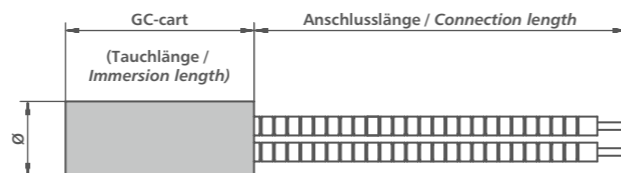
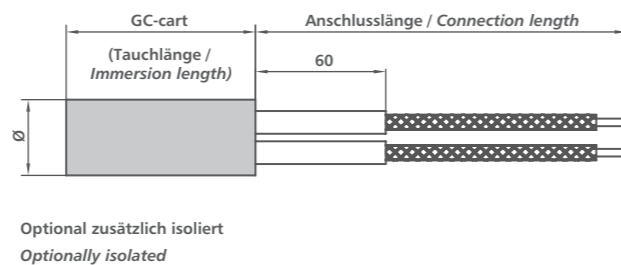
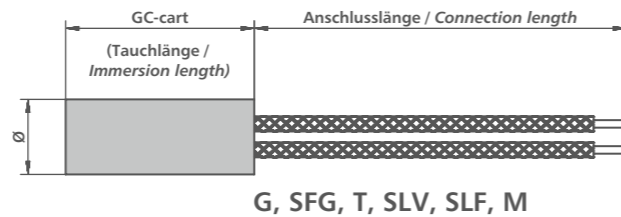

Silikonkabel, max. 180 °C
Silicone cable, max. 180 °C

SIK 2-, 3-, 5-adriges Silikonkabel mit Rohrstück
2-, 3- or 5-wired silicone cable with tube

Ø GC-cart		Ø R x R
6.5	1/4"	7.5 x 40
8.0		9.0 x 40
10.0		11.0 x 40
12.0		14.0 x 40
12.5	1/2"	14.0 x 40
16.0	5/8"	14.0 x 40
20.0	3/4"	18.0 x 40

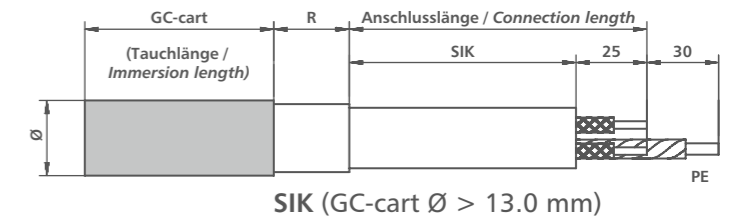
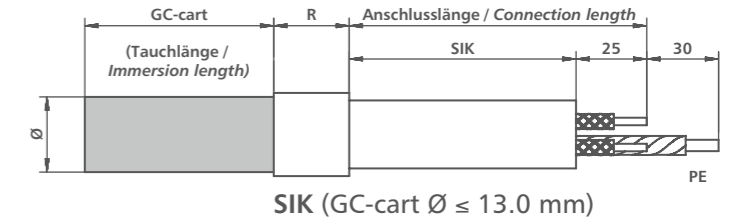

Glasseidenschlauch, max. 250 °C
Glass silk insulated sleeve, max. 250 °C

GHI Einreduzierte Litze mit Glasseidenschlauch
Continuous leads with glass silk insulated sleeve

Ø GC-cart		max. AD GH
8.0		6.0
10.0	3/8"	9.0
12.0		10.0
12.5	1/2"	10.0
16.0	5/8"	13.0
	3/4"	16.0
20.0		17.0

AD = outer diameter

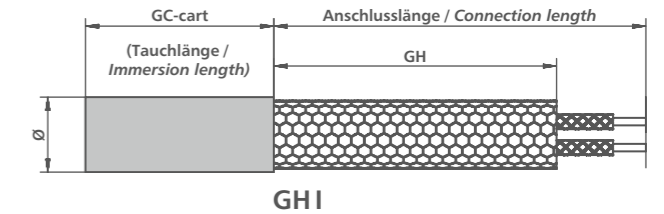

GH Glasseidenschlauch mit Verbindungsrohr
Continuous leads with glass silk insulated sleeve
and tube

Ø GC-cart		Ø R x R	max. AD GH
6.5	1/4"	7.5 x 40	6.0
8.0		9.0 x 40	7.0
10.0	3/8"	11.0 x 40	9.0
12.0		14.0 x 40	11.0
12.5	1/2"	14.0 x 40	11.0
16.0	5/8"	14.0 x 40	11.0
	3/4"	18.0 x 40	17.0
20.0		18.0 x 40	17.0

AD = outer diameter

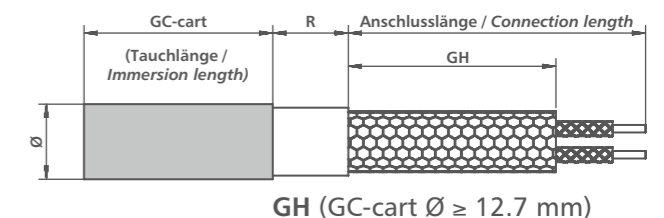
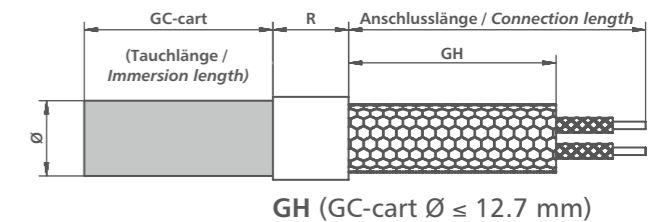

Metallwellschlauch, max. 220 °C
Metal sleeve, max. 220 °C

MWS I Einreduzierte Litze mit Metallwellschlauch von innen
Continuous lead with metal sleeve from the inside

Ø GC-cart	Ø MWS AD
12.0	11.0
12.5 1/2"	11.0
16.0 5/8"	14.0
3/4"	14.0
20.0	17.0

AD = outer diameter

MWS Einreduzierte Litze mit Metallwellschlauch mit Verbindungsrohr
Continuous lead with metal sleeve with tube

Ø GC-cart	Ø R x R	Ø MWS AD
6.5 1/4"	7.5 x 40	7.0
8.0	9.0 x 40	8.0
10.0 3/8"	11.0 x 40	10.0
12.0	14.0 x 40	13.0
12.5 1/2"	14.0 x 40	13.0
16.0 5/8"	14.0 x 40	13.0
20.0 3/4"	18.0 x 40	16.0

AD = outer diameter

Metallgeflechtschlauch, max. 250 °C
Braided metal sleeve, max. 250 °C

MGSI Metallgeflechtschlauch ohne Verbindungsrohr
Braided metal sleeve without tube

Ø GC-cart	Ø R10	Ø MGS
6.5 1/4"	9.0	4.0-6.0
8.0	11.0	4.0-6.0
10.0 3/8"	14.0	5.0-12.0
12.0	16.0	5.0-12.0
12.5 1/2"	16.0	5.0-12.0
16.0 5/8"		5.0-12.0
3/4"		12.0-22.0
20.0		12.0-22.0
25.0		12.0-22.0

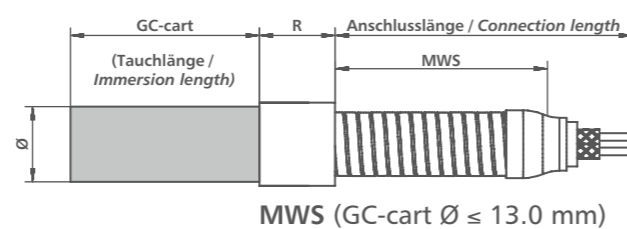
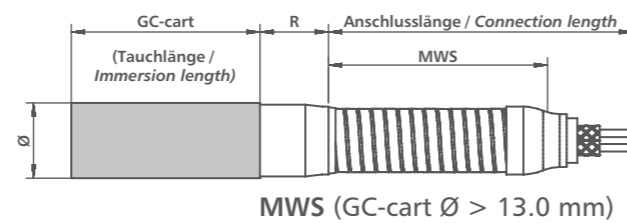
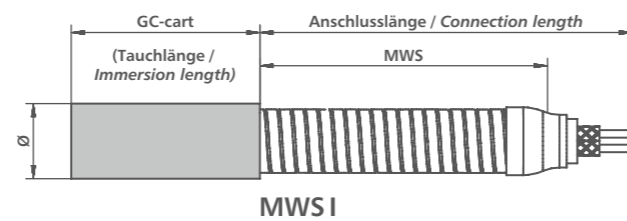

Metallgeflechtschlauch, max. 250 °C
Braided metal sleeve, max. 250 °C

MGS Metallgeflechtschlauch mit Verbindungsrohr
Braided metal sleeve with tube

Ø GC-cart	Ø R x R	Ø R10
6.5 1/4"	7.5 x 40	10.0
8.0	9.0 x 40	11.0
10.0 3/8"	11.5 x 40	14.0
12.0	14.0 x 40	
12.5 1/2"	14.0 x 40	
16.0 5/8"	14.0 x 40	
20.0 3/4"	18.0 x 40	
25.0	22.0 x 40	

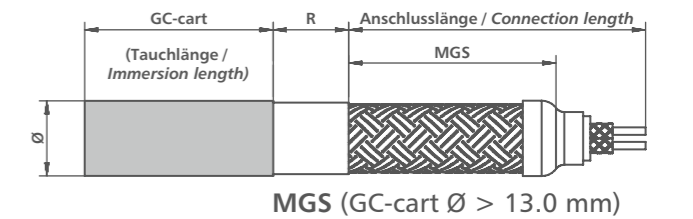
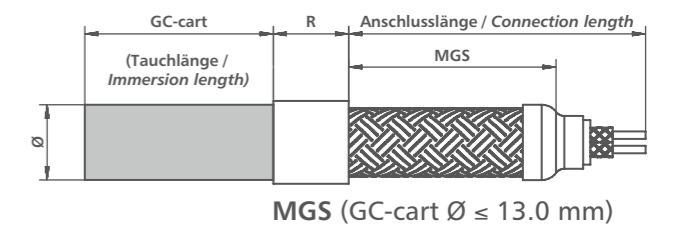
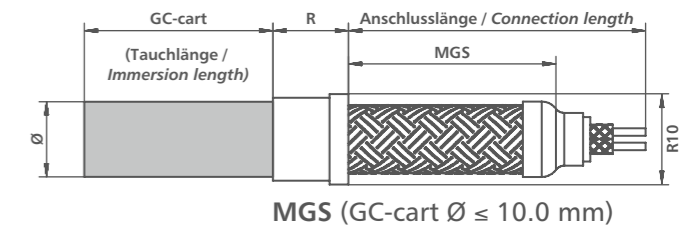

Edelstahlwellschlauch, max. 450 °C
Stainless-steel sleeve, max. 450 °C

RWEI Edelstahlwellschlauch von innen
Stainless-steel sleeve from the inside

RWE Edelstahlwellschlauch mit Verbindungsrohr
Stainless-steel sleeve with tube

Ø GC-cart	Ø R x R	Ø RWE
8.0	9.0 x 40	9.7
10.0 3/8"	11.0 x 40	9.7
12.0	14.0 x 40	12.7
12.5 1/2"	14.0 x 40	12.7
16.0 5/8"	14.0 x 40	12.7
20.0 3/4"	18.0 x 40	16.8

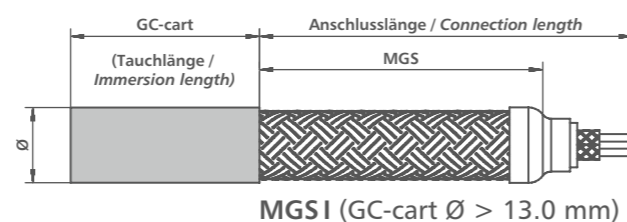
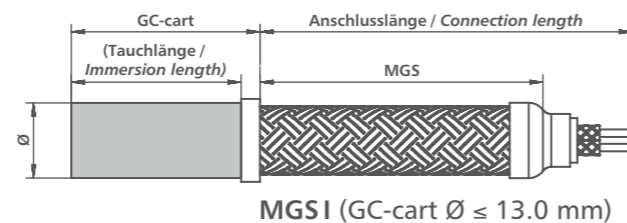
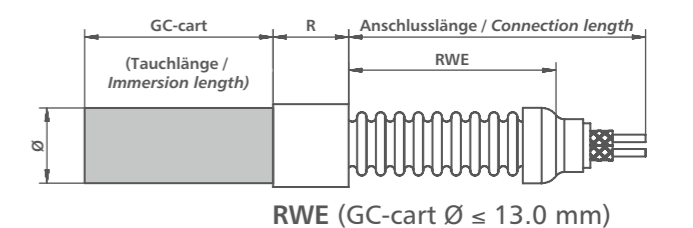
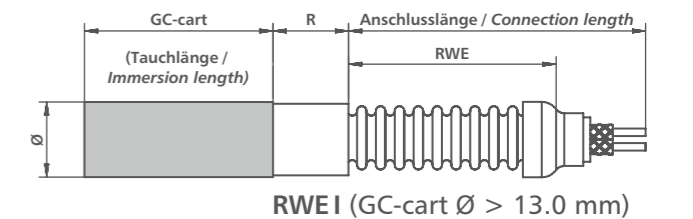

SIS Silikonschlauch mit Verbindungsrohr
Silicone sleeve with connection tube

Ø GC-cart	Variante Type	R1 x R	Ø SIS x Wanddicke Wall thickness	Ø R2
6.0-6.5	außen verpresst outside pressure-grouted	7.5 x 40	9.4 x 1.2	10.5
8.0	außen verpresst outside pressure-grouted	9.0 x 40	11.4 x 1.2	12.5
9.33-10.0	innen verpresst inside pressure-grouted	11.0 x 40	9.4 x 1.2	-
12.0-12.5	innen verpresst inside pressure-grouted	14.0 x 40	11.4 x 1.2	-
15.88-16.0	innen verpresst inside pressure-grouted	14.0 x 40	11.4 x 1.2	-

SIS I Silikonschlauch innen verpresst
Silicon sleeve pressed inside

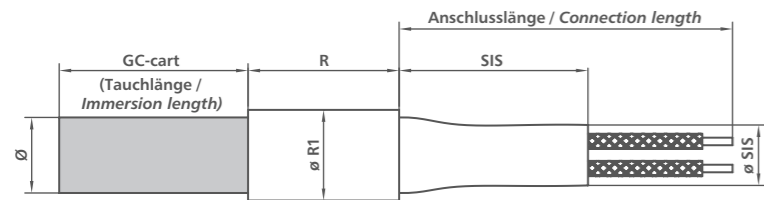

SIS A Silikonschlauch außen verpresst
Silicon sleeve pressed outside

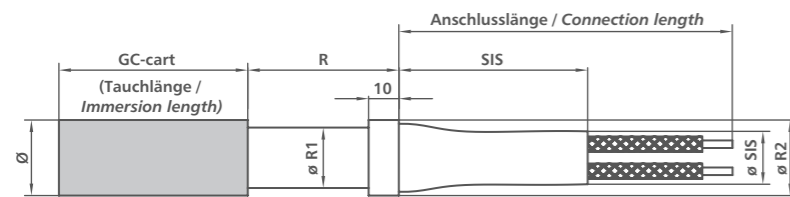

Drehteil
Turned part

DR Rechtwinkliges Drehteil mit Verbindungsrohr
Right-angle turned part with tube

Ø GC-cart	a	b	Ø R x R
8.0	7.8	10.0	8.0 x 40
10.0 3/8"	9.0	12.0	9.0 x 40
12.0	12.0	13.0	10.0 x 40
12.5 1/2"	12.0	13.0	10.0 x 40
16.0 5/8"	15.5	18.0	14.0 x 40
3/4"	19.0	23.0	18.0 x 40
20.0	19.0	23.0	18.0 x 40

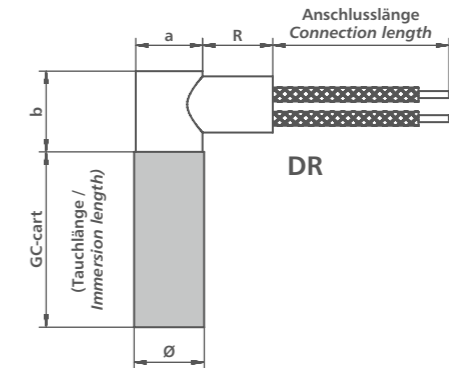

Winkelklotz
Angular block

WR Winkelklotz mit Verbindungsrohr
Angular block with tube

Ø GC-cart	a	Ø R x R
6.5 1/4"	10.0	9.0 x 40
8.0	10.0	9.0 x 40
10.0 3/8"	14.0	11.0 x 40
12.0	14.0	11.0 x 40
12.5 1/2"	14.0	11.0 x 40
16.0 5/8"	18.0	14.0 x 40
20.0 3/4"	22.0	18.0 x 40
25.0	30.0	24.0 x 40
30.0	40.0	28.0 x 40

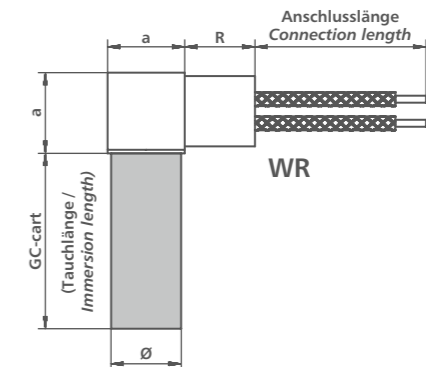

Lasche
Lug

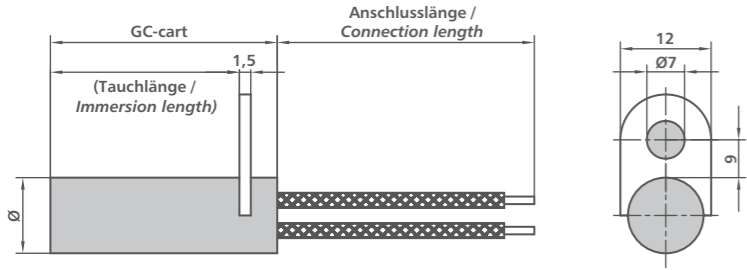

Variante 1: Ø GC-cart < 12
Type 1: Ø GC-cart < 12

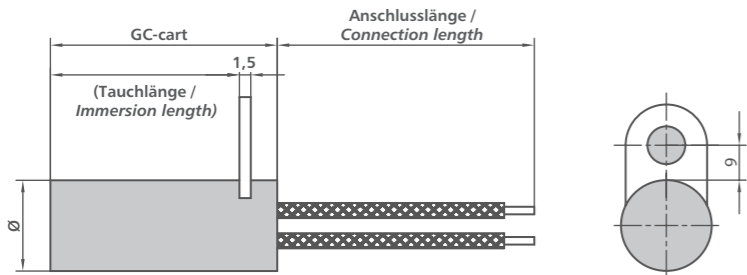

Variante 2: 25 > Ø GC-cart ≥ 12
Type 2: 25 > Ø GC-cart ≥ 12

Flansch
Flange

F1 Flansch, Variante 1
Flange, type 1

Ø GC-cart	Ø F	Ø L	Ø B	t
6.5	1/4"	18.0	13.0	2.2
8.0		18.0	13.0	2.2
10.0	3/8"	27.0	20.0	3.2
12.0		27.0	20.0	3.2
12.5	1/2"	27.0	20.0	3.2
16.0	5/8"	33.0	25.6	3.2
20.0	3/4"	33.0	25.6	3.2
20.0		33.0	27.4	3.5

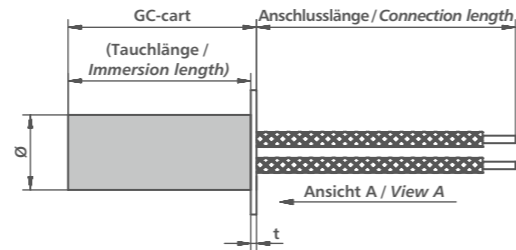

F

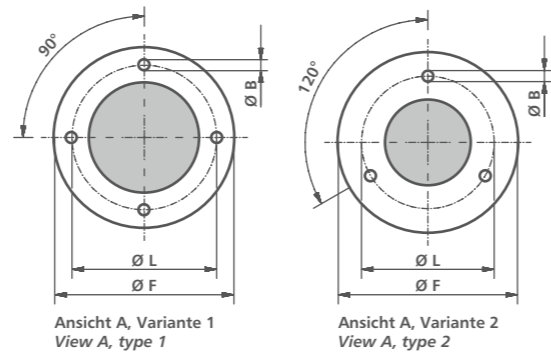

F2 Flansch, Variante 2
Flange, type 2

Ø GC-cart	Ø F	Ø L	Ø B	t
≤ 15.0	35.0	25.0	4.2	2.0
≤ 25.0	44.0	34.0	4.2	2.0
≤ 32.0	52.0	42.0	4.2	2.0
≤ 40.0	62.0	52.0	4.2	2.0

Anschlussgehäuse
Connection housing

BAO Anschlussgehäuse
Connection housing

Ø GC-cart	Ø K	H	N
12.7	31.5	67.0	M16x1.5
16.0	31.5	67.0	M16x1.5
20.0	36.5	67.0	M20x1.5
25.0	36.5	67.0	M20x1.5
32.0	46.5	67.0	M20x1.5
40.0	60.0	60.0	M20x1.5

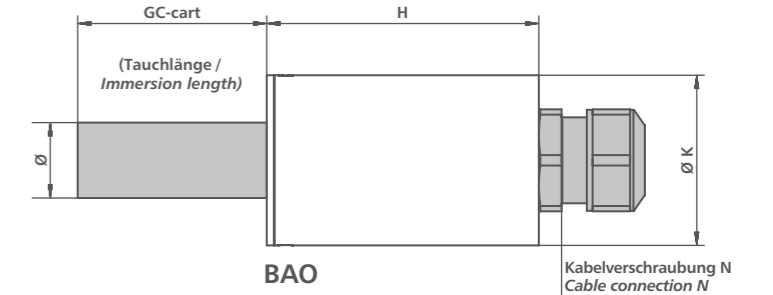

BA/BR Anschlussgehäuse
Connection housing

Ø GC-cart	Gewinde	SW	Ø K	H	N
12.7	G 3/8"	32	31.5	65+7=72	M16x1.5
16.0	G 1/2"	32	31.5	65+8=73	M16x1.5
20.0	G 3/4"	36	36.5	65+8=73	M20x1.5
25.0	G 1"	41	36.5	65+8=73	M20x1.5
32.0	G 1 1/4"	50	46.5	65+8=73	M20x1.5
40.0	G 1 1/2"	60	60.0	60+10=70	M20x1.5

SW = wrench size

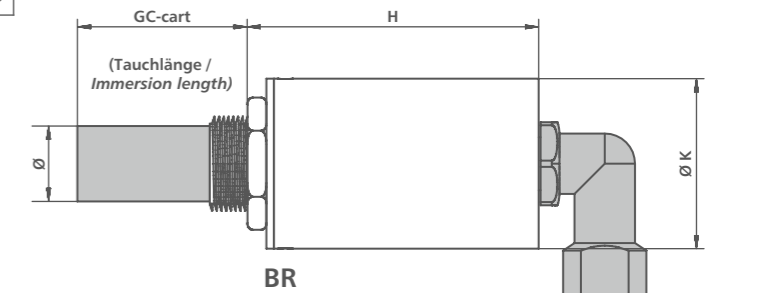
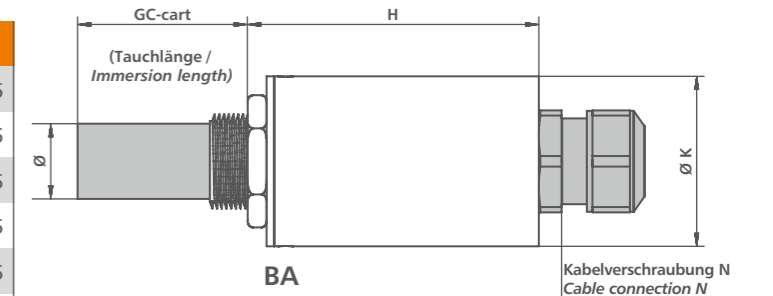

Einschraubnippel
Screw-in nipple

N Einschraubnippel
Screw-in nipple

Ø GC-cart	SW	N	Ø N
6.5	12.0	6.0	M 10 x 1
8.0	14.0	6.0	M 12 x 1
	3/8"	8.0	1/4"
10.0	17.0	8.0	M 14 x 1.5
12.5	19.0	8.0	M 16 x 1.5
	1/2"	8.0	3/8"
	5/8"	8.0	1/2"
16.0	24.0	8.0	M 20 x 1.5
20.0	27.0	10.0	M 26 x 1.5

SW = wrench size

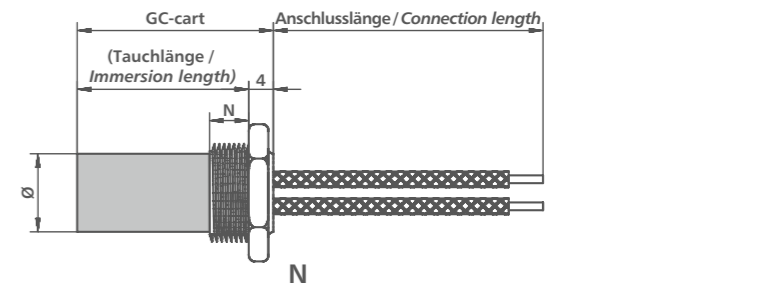



■ made
■ in
■ Germany



ООО «ТИ-Системс» ИНЖИНИРИНГ И ПОСТАВКА ТЕХНОЛОГИЧЕСКОГО ОБОРУДОВАНИЯ
Интернет: www.tisys.ru www.tisys.kz www.tisys.by www.ти-системс.рф
Телефоны для связи: +7 (495) 7774788, (925)7489626, 5007154, 55, 65
Эл. почта: info@tisys.ru info@tisys.kz info@tisys.by